

## DOUBLE WALL SYSTEM DESIGN

Double containment piping systems are one of the most economical and reliable methods for protecting against primary piping leaks of corrosive or hazardous fluids. The Duo-Pro and Fluid-Lok systems offered by Asahi/America are the original and flagship products of the industry. When designed and applied correctly, the system can be expected to have a long service life often exceeding 50 years. Double contained systems constructed from thermoplastic materials offer significant cost savings and superior chemical resistance over their metal counterparts. A combination of government regulations, increased concern over environmental and personal safety, and a growing fear of litigation has hastened the development and improvement of double contained piping components into highly engineered systems. With over 15 years of experience in thermoplastic double containment piping, no other company can match Asahi/America's experience and quality.

Use this guide to assist in the design and layout of a double wall pipe system for multiple applications. This guide highlights the areas of consideration that an engineer should take when designing a system. This section should be used in conjunction with Section C, *Engineering Theory and Design Considerations*, to achieve a proper design.

Cost, reliability, and ease of installation can all be improved by careful planning in the conceptual and design phase of any piping project. Specific to double containment systems, the following items must be given careful consideration:

- When to Use Double Containment Piping
- Materials of Construction
- System Selection
- System Sizing
- Specialty Fittings
- Double Contained Valves
- Thermal Expansion (particularly important in thermoplastic systems)
- Hanging
- Burial
- Welding Methods
- UV Exposure and Weatherability

Leak detection is an important part of double containment systems. Leak detection of some sort is required on all underground double containment systems. The type of leak detection, the installation method, and the system set up are very different from system to system. For this reason, leak detection will be discussed in the next section separately.

## When to Use Double Containment Piping

### Underground EPA Requirements

The U.S. Environmental Protection Agency (EPA) has adopted regulations on underground storage tanks (USTs) and related piping. The EPA states these systems pose threats to the environment. EPA regulation 40 CFR 280 spells out the minimum requirements for USTs that contain petroleum or hazardous chemicals.

A summary of the EPA's requirements that affect double-containment piping follows.

This is a brief overview. A project engineer needs a thorough understanding of the regulations prior to designing a system.

### EPA's Regulations Cover

**Media:** All chemicals listed under Subtitle 1 of 40 CFR 280.

**Systems:** All USTs and related piping.

**System requirements:** All USTs and pipes must be installed so that a release from the product pipe is contained or diverted to a proper collection system. Containment may be done via a trench, dike, or double containment pipe and tanks. The containment materials must be able to hold the leaking product for a minimum of 30 days. By then, scheduled inspections and periodic monitoring should identify the failure and correct the situation.

**Leak detection:** Drainage and suction lines require monthly manual inspections for product line leaks. Pressurized systems require automatic monitoring for product failure. In case of a leak, the system must automatically restrict flow of the product.

**Compliance dates:** The EPA has set requirements for the date of compliance for both new and existing systems. Contact Asahi/America for the latest standard, or visit the EPA's website at [www.epa.org](http://www.epa.org).

**Above ground:** In addition to the EPA requirements for below grade systems, many companies have adopted policies for overhead piping to protect personnel from a possible leak of a harmful chemical.

### Materials of Construction

The majority of double containment systems installed worldwide are thermoplastic due to the ease of joining and chemical resistance to hazardous media, as well as underground moisture. Asahi/America offers several materials to handle a wide range of applications. Materials include:

- Polypropylene
- PVDF
- E-CTFE: Halar®
- HDPE: High Density Polyethylene

The carrier pipe (the inner pipe also known as the product pipe) material is selected based on common piping practices using variables such as:

- What is the chemical(s) to be in contact with the system?
- What are the chemical(s) concentrations?
- What temperature will the system operate at?
- What pressure will the system operate at?
- What is the flow of the media in the system?

By answering these questions, the proper materials of construction for the carrier can be selected for the project. To assist in the material selection, refer to the chemical resistance table in Section E, *Chemical Resistance*. A thermoplastic system's ratings for temperature and pressure are based on water. The addition of certain chemicals will add stress to the system and may reduce the recommended operating parameters. For less aggressive chemicals, the use of printed resistance tables is perfectly suitable. For more aggressive chemicals or mixtures of chemicals, the manufacturer of the pipe system should be consulted.

After verifying the standard operating conditions, it is necessary to examine other operations that might affect the piping. The following is a sample of items to investigate prior to specifying a material.

- Will there be spikes in temperature or pressure?
- Is there a cleaning operation that the piping will be exposed to?
- If yes, what is the cleaning agent? What temperature will the cleaning be conducted at?
- Will the system be exposed to sunlight or other sources of UV?

Each of the above questions should be answered and the desired material should be checked for suitability based on the above factors, as well as any others that might be special to the system in question.

Finally, in addition to verifying the temperature, pressure, and media with the thermoplastic pipe material, it is also necessary to verify other components in the system, such as valves, gaskets, valve seat and seals, etc. These should be examined in the same manner as the pipe material.

Once the product pipe has been selected, the containment pipe must be selected. In most cases, the containment pipe is the same as the carrier pipe, such as in polypropylene and HDPE systems. Using the same material internally and externally yields many time-saving advantages on a project. However, in many systems where the product pipe required is a more expensive material, such as PVDF or E-CTFE, a polypropylene outer shell is often used.

Sizing the containment pipe requires consideration of many factors that are different than those used to size the carrier.

These include:

- Static and live burial loading
- Leak detection requirements
- Hanging requirements for above-ground applications
- Physical space constraints
- Manufacturability and availability
- Operating pressure

When a double contained system is buried, the containment pipe bears the static soil load and the dynamic loading imposed by traffic, equipment, etc. Section C provides a detailed discussion for calculating static and dynamic loading to determine required wall thickness.

Leak detection requirements must also be considered. Depending on the type of leak detection chosen, there may be minimum requirements for the amount of annular space necessary for successful installation and operation. As a general rule of thumb, a minimum of  $\frac{3}{4}$  inches annular space is required for installation of a continuous cable system. Leak detection options are discussed in detail later in this section.

Hanging requirements and physical space constraints are also important considerations. Often, trenches or pipe racks are crowded with other systems, so the containment must not be too large. Hanging criteria including support, restraint, and guide spacing are discussed in Section C. The designer of a system should specify the exact hanger location and not leave this portion up to the installer.

Manufacturability and availability can also influence the selection of containment pipe. There must be adequate clearance between the carrier and containment to facilitate efficient manufacturing. This is especially important for the manufacture of fittings. Asahi/America has spent several years improving fabrication techniques to offer the widest variety of sizes in the marketplace. The designer should also be careful to design with standard pipe sizes to avoid costly delays due to lack of availability.

Operating pressure parameters may be quite different for the containment pipe than for the carrier. Often, systems are designed so that any leaks into the annular space drain directly into a manhole or sump. In these open-ended systems, it is virtually impossible to build up significant pressure. As a matter of economy, the containment pipe often has a lower pressure rating and thus a higher dimensional ratio than the carrier pipe.

The final consideration when choosing the containment pipe is the environment in which it will be installed. Outer UV exposure is not ideal for polypropylene systems and protection of the pipe may be required. If surrounding temperatures are extremely low, then certain materials will become brittle in the cold. Consult Asahi/America for specific recommendations in these cases.

### System Selection

As stated in the previous section, the material must be selected based on the media to run through the system, as well as the operating conditions such as pressure, temperature, and media concentration. In a double containment system, the selection of pipe and associate pipe pressure ratings can be complex, as any combination of material can be used. Table D-1 lists possible pipe ratings that can be used for both the inner and outer pipe wall.

**Table D-1. Pressure Ratings and SDR Values**

System Name	Material**	Pressure Rating (psi)	Standard Dimensional Ratio
PRO 150	Polypropylene	150	SDR 11
PRO 90*	Polypropylene	90	SDR 17
PRO 45	Polypropylene	45	SDR 33
PVDF 230	PVDF	230	SDR 21
PVDF 150	PVDF	150	SDR 11
HDPE 150	High Density PP	150	SDR 11
HDPE 90	High Density PP	90	SDR 17
HDPE 45	High Density PP	45	SDR 33
Halar®	E-CTFE	Non-Standard	

\* Available, but less common. \*\* Not all materials are available in every diameter size.

In addition to all the choices in material, Asahi/America offers three systems for double containment piping.

- Duo-Pro
- Poly-Flo
- Fluid-Lok

Each system has its ideal purposes and advantages. A description of the three systems follows.

### Duo-Pro

The Duo-Pro system is the flagship of the Asahi/America double containment piping system offerings. Duo-Pro is available in polypropylene, PVDF, and E-CTFE, and in any combination of the three. Duo-Pro is available in systems ranging from 1" x 3" to 18" x 24". In addition, larger systems have been made available on request.

Duo-Pro is a fabricated system made from extruded pipe and primarily molded fittings. It has a complete range of molded pressure fittings that are fabricated at the factory into double containment fittings. In addition, Duo-Pro is ideal for drainage applications, having a complete compliment of fittings for drainage applications. It can be assembled using simultaneous butt fusion or staggered butt fusion.

The Duo-Pro system is assembled using a support disc on each end of a pipe or fitting. The support disc centers the carrier inside the containment and locks the two pipes together for simultaneous fusion. On pipe runs, the spider clip fitting is used to support the pipe inside the containment piping. Spider clips are spaced based on hanging criteria by size and material and are designed to avoid point loading of the pipes.

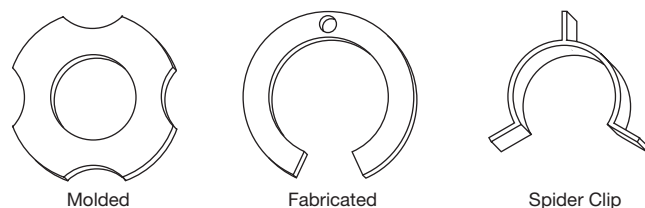

**Figure D-11. Support discs and spider clip fittings**

Per the EPA's requirements, any double contained system needs to have leak detection. The methods of leak detection include manual inspection, low point sensors, and continuous leak detection cable. Leak detection cable is installed in between the annular space between the inner and outer pipe. Duo-Pro is designed to provide sufficient space for the installation of leak detection cable. Contact Asahi/America technical staff for an exact recommendation.



**Figure D-12. Duo-Pro piping system**

### Poly-Flo

The Poly-Flo system is a unique dual extruded and molded system. In all other double containment pipe systems, the inner and outer components are made separately and then assembled into a double wall configuration. This adds time and labor to each project. The Poly-Flo system produces both the inner and outer piping at the same time. Asahi/America's patented extrusion process locks the pipe together by use of continuous support ribs. In addition, most fittings in the system are molded as one piece components. The only deviation is HDPE material, where many fittings are fabricated from double wall pipe.

Poly-Flo is available in 1" x 2", 2" x 3", and 4" x 6". (Consult Asahi/America for the availability of 6" x 8".) Poly-Flo is available in three materials: black polypropylene (UV stabilized), PVDF, and HDPE. It is a unique system, where the carrier pipe has an OD consistent with IPS pipe, while the outer pipe is a jacket not corresponding to an IPS dimension.

Poly-Flo is assembled using simultaneous butt fusion only. The system is available with manual and low point leak detection sensors only. The use of leak detection cable is not possible due to the limited annular space.



**Figure D-13. Poly-Flo piping system**

**Fluid-Lok**

The Fluid-Lok system is an all HDPE system. It is manufactured in a similar process to the Duo-Pro system. Fluid-Lok is available in many sizes ranging from 1"x 3" to systems as large as 36"x 42".

Besides being an all HDPE system, Fluid-Lok is different than Duo-Pro in that most fittings are fabricated and not molded. Fabricated fittings are ideal for the application of long sweep 90's and 45's, often required in these systems. Fluid-Lok is designed to accommodate leak detection low point sensors or cable. In addition, HDPE manholes are available and can be directly welded to the pipe system to avoid unnecessary fittings and provide more consistency and leak protection.



**Figure D-14. Fluid-Lok piping system**

The availability of many materials and three piping systems creates many choices. Each system is designed for specific applications and assembly techniques. To assist in the proper selection of the system, answer the following questions.

**Question/Answer**

- Q: Are you operating under pressure or drainage?
- A: Pressure systems may need to have consistent pressure rating fittings on both the carrier and containment pipe. DWV fittings are not allowed in pressure systems.
- Q: Do you require consistent pressure ratings on the carrier and containment?
- A: If not, cost can be saved by using 150 psi carrier piping and 45 psi containment piping.
- Q: What material are you using?
- A: Material requirements may determine the system you can choose.
- Q: Do you require continuous cable leak detection?
- A: Only the Duo-Pro and Fluid-Lok systems can accommodate cable systems.

Based on knowing the operating parameters and the desired material, one of the following systems can be chosen for the installations.

**Table D-2. Double Containment Systems**

Product Name	System Name**	Material	Size Range (inches)
PRO 150 x 150	Duo-Pro	Polypropylene	1 x 3 to 16 x 20
PRO 150 x 45	Duo-Pro	Polypropylene	2 x 4 to 18 x 24
PRO 45 x 45	Duo-Pro	Polypropylene	4 x 8 to 18 x 24
PVDF x Pro 150	Duo-Pro	PVDF x Polypro	1 x 3 to 12 x 16
PVDF x Pro 45	Duo-Pro	PVDF x Polypro	2 x 4 to 12 x 16
PVDF x PVDF	Duo-Pro	PVDF x PVDF	1 x 3 to 8 x 12
Poly-Flo BPP	Poly-Flo	Black Polypropylene	1 x 2, 2 x 3, 4 x 6
Poly-Flo PVDF*	Poly-Flo	PVDF	1 x 2, 2 x 3
Poly-Flo HDPE	Poly-Flo	HDPE	1 x 2, 2 x 3, 4 x 6
HDPE SDR 21x21	Fluid-Lok	HDPE	1 x 3 to 16 x 20
HDPE SDR 17x17	Fluid-Lok	HDPE	3 x 6 to 18 x 24
HDPE SDR 17x33	Fluid-Lok	HDPE	3 x 6 to 18 x 24
HDPE SDR 33x33	Fluid-Lok	HDPE	3 x 6 to 18 x 24

\* Consult factory for availability.

\*\* Fluid-Lok is available in other SD ratios, as well as larger dimensions.

**System Sizing**

In Section C, *Engineering Theory and Design Considerations*, there is a detailed discussion on fluid dynamics and determination of flow rates and pressure drops. It is recommended when using any thermoplastic with a hazardous chemical to maintain flow rates below a velocity of 5 ft/second. High velocities can lead to water hammer in the event of an air pocket in the system. Water hammer can generate excessive pressures that can damage a system. For safety reasons, high velocities should be avoided.

In addition, high velocities also mean added pressure drop, which, in turn, increases demand on the pump. If the flow velocity is not required, it is recommended to size a system with

minimal pressure drop. It is also recommended to oversize a design to allow for future expansion or chemical demand. Once a system is in place, it is difficult to add capacity to it.

### Specialty Fittings

Double containment systems, for the most part, can be thought of in the same manner as single wall piping systems with a few exceptions. In a double wall system, the issue of thermal expansion is more complicated (see next page), welding is similar but not the same, and finally, the outer containment pipe must have a start and stop.

The major fitting that sets Asahi/America systems apart from all other double wall systems is the patented Dogbone force transfer fitting. The Dogbone fitting can be used in many ways to assist in the design of a proper double containment piping system.

The Dogbone is used for:

- Locking the inner and outer pipes together
- Compartmentalizing pipe section
- Termination of the containment pipe
- Sensor installation
- Control of thermal expansion

Figures D-15 through D-18 depict a few uses of the Dogbone.

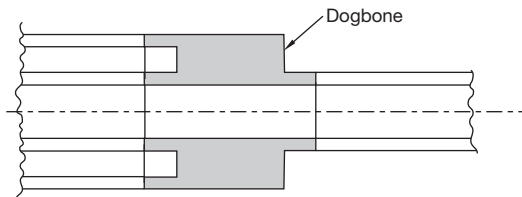

Figure D-15. Outer containment termination

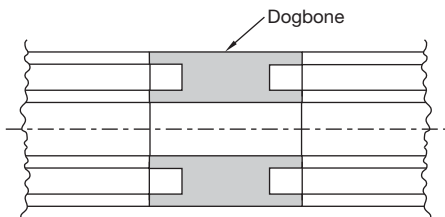

Figure D-16. Locking inner and outer pipes

Dogbones are available in solid and annular forms. A solid Dogbone does not allow the passage of fluid in the annular space to pass through, while annular Dogbones will allow the passage. The placement and purpose of the fitting will determine the style required.

Dogbone fittings are available in the Duo-Pro and Fluid-Lok system. The Poly-Flo system does not require the fitting, as the pipe is continuously supported and locked together.

Finally, the Dogbone can be used for connecting in low point leak detectors, ventilation, and drainage. When designing a double wall system, it is important to incorporate high point vents to eliminate air from the system. In addition, in the event of a leak, a drainage method for the containment pipe is required. Connection methods for these valve requirements are shown in Figures D-17 through D-20.

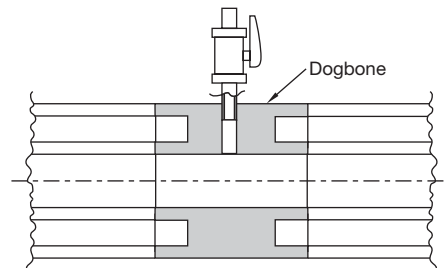

Figure D-17. Ventilation of inner pipe: Duo-Pro and Fluid-Lok

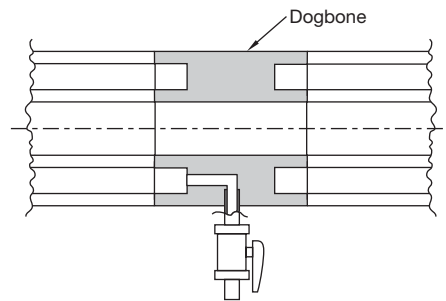

Figure D-18. Drainage of containment pipe: Duo-Pro and Fluid-Lok

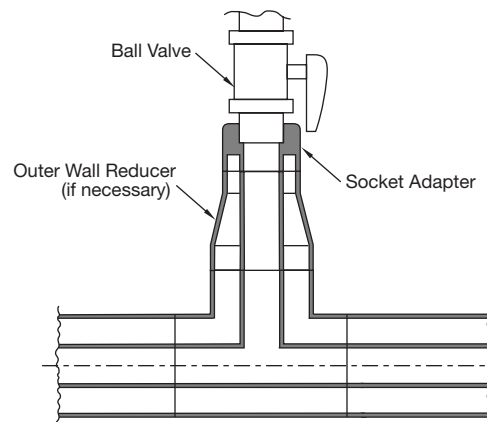
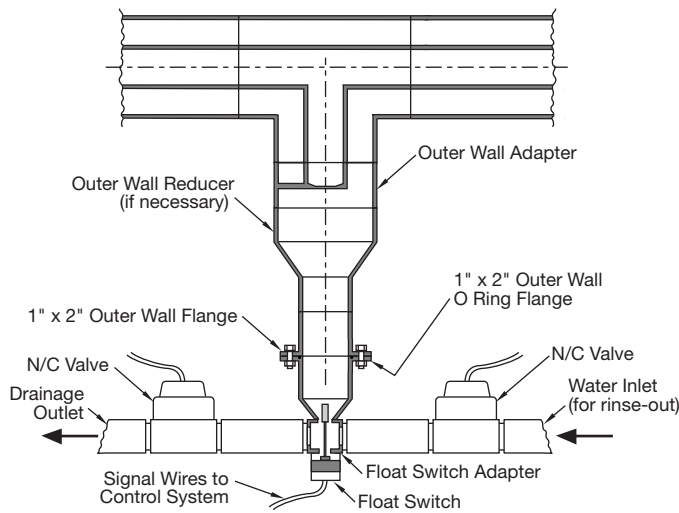

Figure D-19. Ventilation of inner pipe: Poly-Flo system



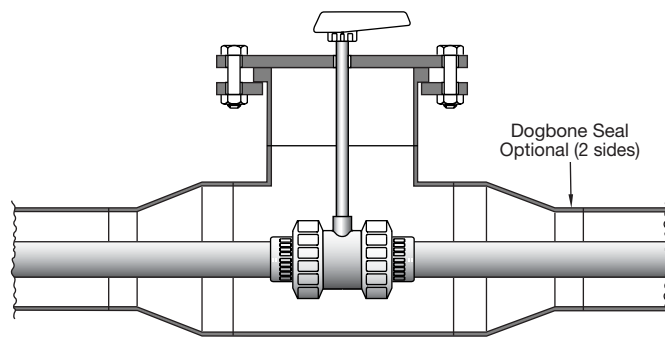

**Figure D-20. Drainage of containment pipe: Poly-Flo system with low point sensor**

**Double Contained Valves**

In pressurized systems, the necessity of valves can be accomplished without interrupting the integrity of the double containment system. Double contained valves are available in many shapes and forms. Double contained valves are available in any style valve such as ball, butterfly, diaphragm, check, and gate. The valve selected, based on the application, determines the shape of the outer containment.

The following figures demonstrate a few valve configurations that are available from Asahi/America, Inc. Other options are readily available on request.



**Figure D-21. Double contained ball valve with stem extension: Duo-Pro system**

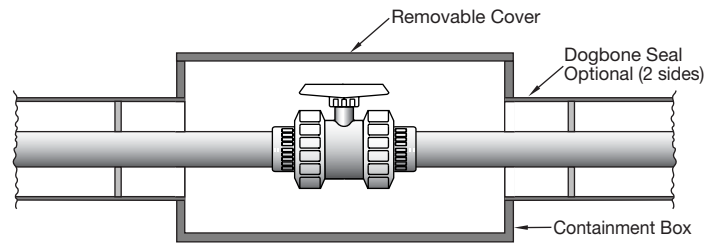

**Figure D-22. Double contained ball valve without stem extension: Poly-Flo system**

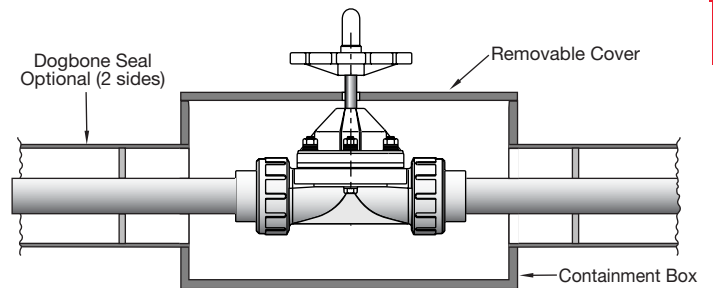

**Figure D-23. Double contained diaphragm valve with stem extension: Poly-Flo system**

More than valves can be installed. Items such as flow meters, and temperature and pressure monitors can also be incorporated into the internal containment portion of the system. Contact Asahi/America's Engineering Department to discuss your particular needs. It is important to specify and design in the need to access valves for maintenance purposes.

**Thermal Expansion**

Based on your operating criteria, thermal expansion must be considered. For systems maintained at consistent temperatures, compensation for thermal effects may not be required. In a double contained piping system, three types of expansion can occur:

- Carrier pipe exposed to thermal changes, while containment remains constant. Typically possible when carrier pipe is exposed to liquids of various temperature, while outer containment is in a constant environment such as in buried applications.
- Containment piping experiences thermal changes, while carrier remains constant. Typical application is outdoor pipe racking with constant temperature media being transported in carrier.
- Both inner and outer experience temperature changes.

The Dogbone fitting is a proven and effective way to control thermal expansion where a restrained system is acceptable. It can also be used to direct the growth of a flexible system. For systems maintained at consistent temperatures, compensation for thermal effects may not be required. It is, however, impor-

tant to review all aspects of the operating environment such as:

- Is it outdoors where it will be exposed to changing weather?
- Is the system spiked with a high temperature cleaning solution?
- Will the system run at a significantly higher or lower temperature than the installation temperature?

The occurrence of any thermal change in a plastic system will cause the material to expand or contract.

Thermoplastic systems can be used in hot applications and applications where the temperature is cyclical; it just requires analysis of the thermal expansion effects. Section C, *Engineering Theory and Design Considerations*, walks through the steps of calculating thermal expansion, end loads, and expansion compensating devices. In most cases, the use of expansions, offsets, and proper hanging techniques are all that is required to ensure a proper design.

Hot systems also reduce the rigidity of thermoplastic piping, which, in turn, decreases the support spacing between hangers. In smaller dimensions, it is recommended to use continuous supports made of some type of channel or split plastic pipe.

Finally, the use of hangers as guides and anchors becomes important. As the design procedures in Section C indicates, certain hangers should be used as guides to allow the pipe to move in-line, while other hangers should be anchoring locations used to direct the expansion into the compensating device. The anchors and hangers should be designed to withstand the thermal end load.

In a buried system, the standard Dogbone fitting will lock the inner and outer pipe together. The surrounding ground and fill should eliminate the movement of the outer pipe. In systems that are hung, the outer pipe hanger must withstand the thermal end load. To properly hang these systems, a special Restraint Dogbone is recommended at the hanger locations.

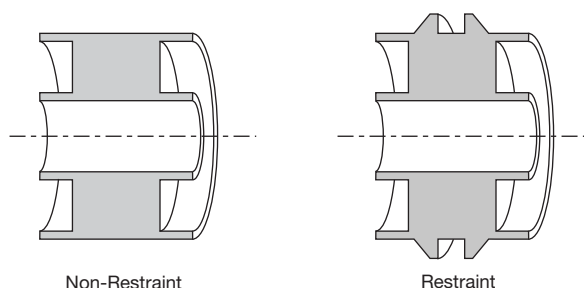

**Figure D-24. Dogbones**

For calculation of allowed stresses and design of expansion compensation devices, refer to Section C, *Engineering Theory and Design Considerations*.

## Hanging

See Appendix A for proper hanging distances by size and material. As in any thermoplastic system, the selection of hangers is an important decision. Hangers that scratch or create point loads on the pipe are not recommended. The ideal hanger is a thermoplastic component. In many cases an all plastic hanger may not be available. In these cases a metal hanger is acceptable, but precautions should be taken. Any sharp edges on the hanger should be removed. A cushion made of rubber is recommended in the event that the pipe shifts, thus preventing scratching.

Section C provides detailed recommendations on hanging double containment pipe. Please consult this section prior to specifying the hangers.

## Burial

Due to EPA requirements, burial of double containment piping is a common practice. In most cases, the burial of double wall pipe is the same as that of a single wall pipe system. Careful consideration of the soil type, compaction, trench detailing, back fill, load, etc. are necessary to consider in the proper design. Section C, *Engineering Theory and Design Considerations*, provides a step-by-step detailed process of how to properly bury the system.

Live loads also pose the added complication when burying a system. It is important to look at the possibility of the pipe system being driven over, as well as the type of vehicle that would be creating the live load.

In the design it is imperative to call out the recommendations of the burial in the details of the drawing set. By calling these details out, the contractor will be in a better position to properly install the pipe as required.

## Welding Methods

All double containment systems offered by Asahi/America, Inc. are available for butt-fusion assembly. Butt fusion provides reliable fusion, but is also ideally suited for the double wall system. By properly aligning the carrier and containment piping with the support disc, both the inner and outer pipe can be welded at the same time. This reduces the assembly time, as well as the need for extra fittings such as couplings. What can be accomplished in one weld can take up to 4 welds in other systems (weld the inner and outer separately on either side of a coupling).

When building a system that is made of dissimilar materials (example: PVDF x Pro 45), the pipes cannot be welded simultaneously due to different heat and joining force requirements. For these systems staggered welding is required, where the inner pipe is welded first and the outer pipe welded second using a special annular heating element. Staggered fusion does take more time due to the extra welds, but still proves econom-

ical when compared to using like materials such as PVDF on both the carrier and containment pipe depending on pipe size, project requirements, and installation environment.

See Section F, *Installation Practices*, for detailed information on double containment welding methods.

### UV Exposure and Weatherability

All thermoplastic materials react to the exposure of UV differently. PVDF and E-CTFE materials are completely UV resistant over the course of its design life. However, certain chemicals containing Cl anions exposed to UV light can create a free radical Cl that will attack the PVDF pipe wall. For more information on these chemicals, refer to Section F, *Good Installation Practices*, on weatherability and UV exposure of the piping.

Polypropylene is not UV stable. In direct exposure to sunlight it will break down. The effect can be seen in a noticeable color change in the pipe. In pigmented PP systems, the color change will actually create a protective shield on the outer layer of the pipe and prevent further degradation. For PP pipes with a wall thickness greater than 0.25", the effect of UV is normally reduced and can be used outside. However, it is still recommended to protect it from UV exposure for added safety.

The Fluid-Lok HDPE material is UV stabilized. Fluid-Lok pipes contain carbon black to make the material UV stable and acceptable for use in outside applications. Other HDPE materials made by other manufacturers may require protection. Be sure to consult a manufacturer prior to selecting a pipe system.



## LEAK DETECTION DESIGN

In all buried applications of double containment piping, the EPA (40 CFR 280) has set a requirement for leak detection. Drainage and suction lines require monthly manual inspections for product line leaks. Pressurized systems require automatic monitoring for product failure. In case of a leak, the system must automatically restrict the flow of the product.

Asahi/America's systems are designed to accommodate many different technologies for detecting a leak. The following methods are acceptable:

- Low point leak detection sensors
- Continuous leak detection cable systems
- Visual inspection (only acceptable on drainage systems)

The selection of the leak detection system will play a critical role in the layout of the piping system. For instance, if a cable method is used, it will require additional fittings called access ports for pulling the cable. Pipe and fittings will need to be ordered with pull ropes installed at the factory. And finally, the placement of the cable will need to be factored in. In some installations only the main trunk line will have cable; while in others, the cable will split and run up each of the branch lines.

This guide has been created to assist in the pipe layout and design of a leak detection system. Each type of system is discussed below in regard to its use in an Asahi/America double containment piping system.

### Low Point Leak Detection Sensors

Low point leak detection sensors can be used in any of Asahi/America's double wall systems.

- Poly-Flo
- Duo-Pro
- Fluid-Lok

For the Poly-Flo system, low point sensors are the only automatic system available.

Low point leak detection is relatively straightforward in terms of design. The sensing technology consists of either capacitive or float type switches. These switches are placed in strategic locations throughout a system to properly identify leaks and then determine their location within a reasonable length of pipe. If an insufficient amount of sensors are used and a leak occurs, determining the location of that leak can be extremely difficult, especially if the piping is buried. It is always more practical to use a few more sensors at the time of installation, as it could be a huge cost savings in the long run in the event of a system leak.

### Mounting of the Sensor

Asahi/America pipe systems can accommodate mounting sensors in a variety of different methods. In some cases, it is ideal to place the sensor with as tight a profile to the pipe as possible; in other instances, a low point leak sensor installation may

also require a valve for drainage. When using low point sensors in below grade applications, it is important that special considerations in the excavation are taken to ensure that sensors are not damaged during installation or during back fill.

Figures D-25 through D-28 depict a few assemblies for mounting low point sensors into the annular space of a double contained pipe system.

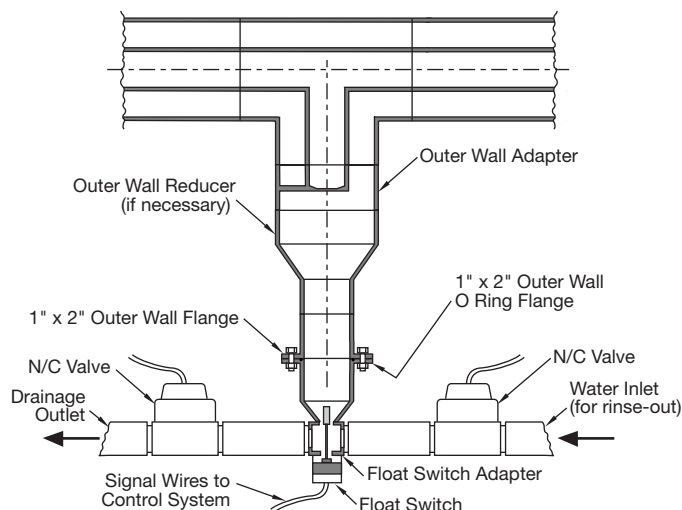

Figure D-25. Drain and low point Poly-Flo system

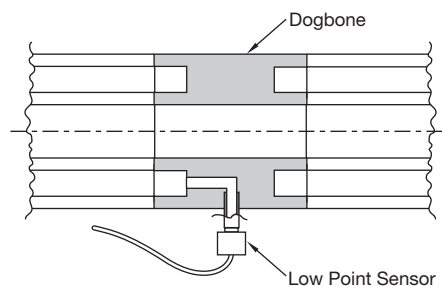

Figure D-26. Simple connection, Duo-Pro/Fluid-Lok systems

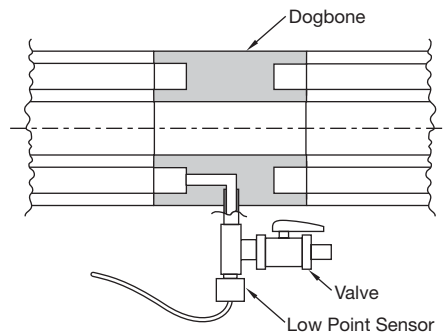
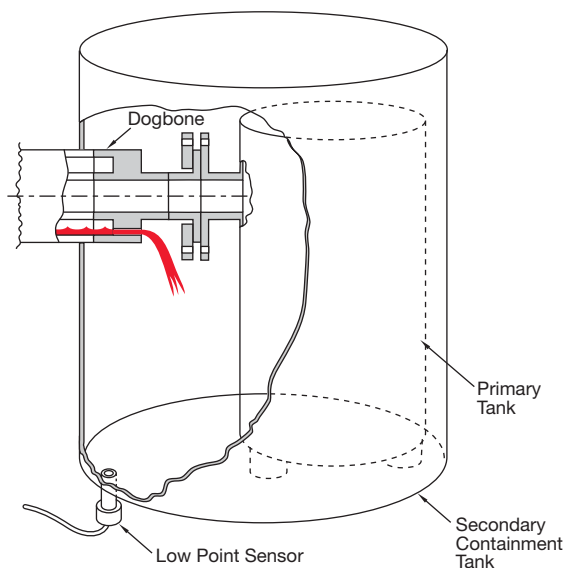

Figure D-27. Connection with drain valve, Duo-Pro/Fluid-Lok systems

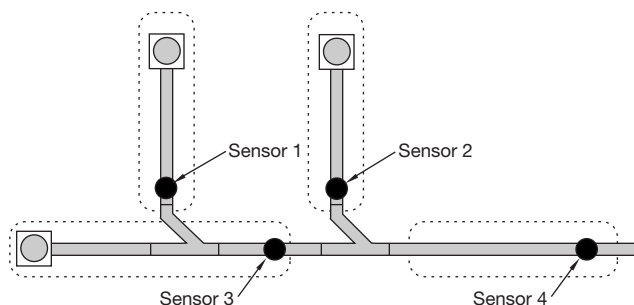

**Figure D-28. End-of-line connection option, Duo-Pro/Fluid-Lok systems**

#### Location of the Sensors

The location of sensors should be based on finding the leak with relatively no confusion. By placing the sensors on the branch of tees or lateral (wye) type connections, the line causing the leak is identified. In addition, placing the sensor every 100 to 150 feet also reduces the area that would be in question if a leak was to occur.

Figure D-29 shows an example of a system and the ideal locations for the low point sensors.



**Figure D-29. Sample locations for low point sensors**

#### Compartmentalizing the System

The practice of compartmentalizing the outer containment pipe is in conjunction with strategic placement of sensors. If a major leak were to occur, it is possible that more than one sensor could be tripped in a short time frame. If you have no way of knowing which sensor tripped first, then the value of multiple sensors is lost.

Using the Dogbone fitting, sections of the annular space can be made into individual compartments. In the case of a leak, the fluid will pass into the annular space, but will be locked into a compartment and not allowed to spread throughout the system. This method has two advantages: one helps to identify leak locations, the other reduces the need to dry out a large section of the annular space once the leak is found and repaired.

Figure D-30 demonstrates the use of solid Dogbones to create compartments.

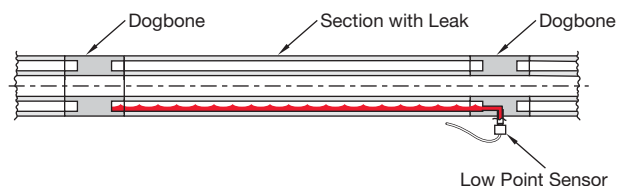

**Figure D-30. Leak detection compartments**

#### Continuous Cable Leak Detection Systems

Continuous cable leak detection systems offer the best method for locating a leak in the annular space of a double containment pipe system. A cable system can generally pinpoint the location of the leak with an accuracy of  $\pm 0.5$  feet. It can also incorporate low point probes to offer maximum flexibility to the designer. Entire systems can be mapped out, installed, and fed back to an easy to understand operating panel. Most large systems use leak detection cable as the preferred method for monitoring the system.

All pressure double wall pipe systems are required to have automated leak detection in below grade applications. In these cases, cable is the recommended method.

The discussion of leak detection cable is broken down into two topics: the pipe layout requirements and the electrical cable layout requirements.

#### Pipe Layout Requirements (Annular Space)

Leak detection cable can be used in the following Asahi/America systems:

- Duo-Pro
- Fluid-Lok

Unfortunately due to the narrow annular space in a Poly-Flo system, the cable cannot be pulled through the system, eliminating its use. Continuous cable systems require a minimum of 0.75" of annular space to pull cable through easily. In Duo-Pro and Fluid-Lok systems, certain pipe configurations can have small annular space making the cable pull difficult or impossible. For instance, 1 x 3 Pro 150 x 150 Duo-Pro systems have a 0.813 space all around. After accounting for the weld bead, the

space will be lower than 0.75". For this application, 1 x 4 Pro 150 x 150 or 1 x 4 Pro 150 x 45 should be considered to ease the installation. Consult Appendix A for the available annular space on Duo-Pro systems. For Fluid-Lok systems, consult Asahi/America's Engineering Department.

To clarify once again, for ease of installation the annular space needs to be a minimum of 3/4" to accommodate easy cable pulls.

## Pipe

There are no special requirements for pipe. Both the Duo-Pro and Fluid-Lok systems are designed to accommodate cable leak detection. Support discs on the ends of pipe and fittings provide a wide opening on the bottom of the pipe, as well as either cut outs or vent holes in other sections, depending on the pipe size. On pipe runs, the carrier pipe is supported by use of spider clips, which support the carrier pipe without blocking the bottom of the annular space.

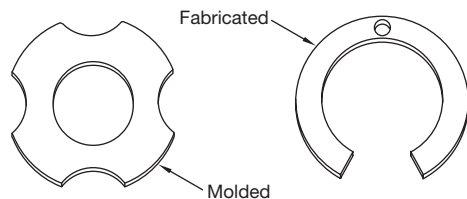

**Figure D-31. Two typical end of pipe support discs to accommodate leak detection**

There are only two important items to keep in mind. When ordering pipe, ensure that pull rope is ordered to be installed on the pipe. The second is during installation. **It is critical to align pipe and fittings properly to ensure that support disc openings are located on the bottom.** Forgetting this can lead to significant difficulty when trying to pull cable into the system.

## Access Points

Asahi/America offers a standard fitting for accessing the annular space known as the Access Tee or Pull Port Tee. While it can be common practice in HDPE systems to cut windows into the pipe to access the rope or cable, and then weld a saddle on afterwards, this is not an acceptable design. While it is possible to cut windows, this should only be used when the rope or cable is caught in the line and no other alternative is available.

Access tees are supplied with a low pressure thread on cap, or for full pressure rating on the outer wall pipe, a flange and blind flange configuration is available.

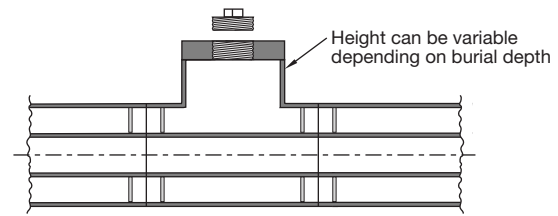

**Figure D-32. Access tee with threaded cover**

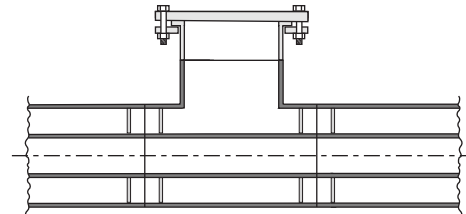
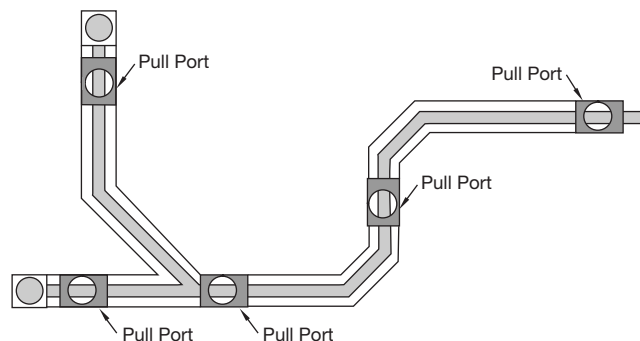

**Figure D-33. Access tee with flanged cover**

Access tees are supplied in two pieces, allowing the installer to weld the proper pipe height to the tee base to come up to grade.

Once the selection of the access tee style is determined, then the strategic location of the pull ports is required. In general, pull ports should be located at no more than 500-foot intervals on straight runs. Each 90° change in direction is approximately equal to 150 feet of straight run. Pull ports should be installed to avoid binding the pull rope. Access tees should also be placed at the beginning and the end of branch locations requiring cables. For tie-ins to the main cable, it is best to place the access tee on the main run in front of the branch location.

Figure D-34 shows a small schematic on a drainage system and the proper location of the access port.



**Figure D-34. Pull port locations for leak detection cable**

### Dogbones in a Cable System

In a double containment system, the Dogbone fitting is used to lock the inner pipe together for proper restraint or for the control of thermal expansion. Unlike low point systems, creating compartments in the system is not practical. If Dogbone fittings are required in the system, the use of the annular style is required to allow cable to pass through.

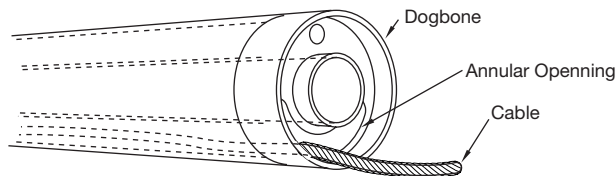

Figure D-35. Annular Dogbone with cable

### Sensor Cable Requirements

#### Sensor Cable

Proper selection of the sensor cable is imperative to the successful operation of any leak detection system. Most systems use a specially designed coaxial cable for sensing leaks. Some cables are designed to sense only water, others are designed to sense corrosive chemicals, and some are designed to sense the presence of hydrocarbons. There are also combinations of these available that can sense corrosive water-based liquids while ignoring hydrocarbons and vice versa; or there are some cables that can sense water and hydrocarbons. These selections increase the flexibility of system applications. The chemistry of the media must be considered to ensure proper selection of the sensing cable.

#### Jumper Cable

Jumper cable is used to connect sensor cable segments and probes together to form the sensing string. Jumper cable is not affected by contact with water. However, installation in conduit is recommended to prevent physical damage. If needed, jumper cable can be direct buried.

#### The Connectors

The cable connection is perhaps the most critical component to a hassle free commissioning of the system. Factory training of all personnel installing connectors is strongly recommended to save many hours troubleshooting a system with poor connections. The connectors are typically standard UHF coaxial cable connectors that are connected together with an adapter. Since there is the possibility of the connection getting wet in the event of a leak, each connection must be carefully sealed with shrink tubing upon commissioning of the system.

#### The Control Panel

The control panel is the heart of the leak detection system. It is typically mounted in a location that is convenient for an operator to monitor its status. The control panel can be ordered in several configurations. Some are multi-channel devices that are

capable of monitoring several systems simultaneously. Care must also be taken to specify a panel that is capable of monitoring the required length of sensor cable. The control panel should have a visual readout of some sort, as well as a keypad for operation. It should also provide provisions to interface with a computer to use diagnostic and programming tools that are available.

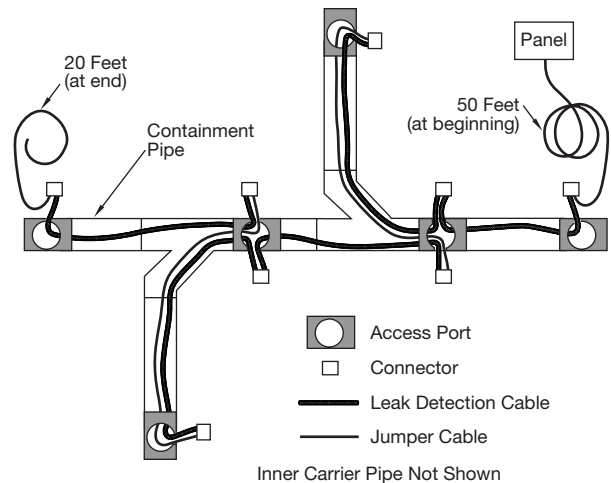

Figure D-36. Layout of the cable with jumpers

### Visual Inspection Monitoring

In drainage only applications, an alternative method to automated leak detection is manual inspection. As long as monitoring can be accomplished every 30 days and recorded, manual inspection is allowed. For manual inspection, low point drains are placed at collection points in line as required. By designing in wells, systems can be opened and the annular space inspected to sight a possible leak. Manual inspection can also be accomplished at the end of the line. Figures D-37 and D-38 show two possible designs for manual leak detection. Probes can also be placed in wells as a manner of automated detection with a view point.

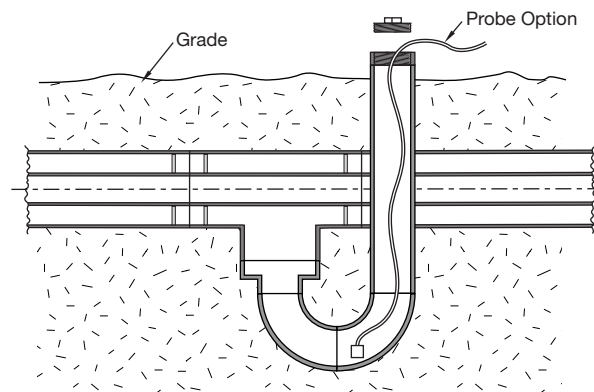

Figure D-37. In-line inspection well

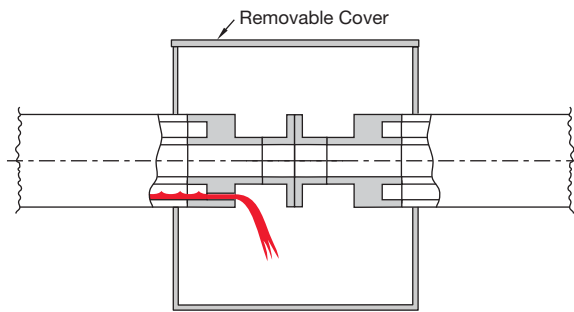

Figure D-38. End-of-line inspection well

D



**VENTILATION SYSTEM DESIGN**

In the past 10 years thermoplastic materials have started to be used for ventilation applications. A thermoplastic vent system provides many features that standard sheet metal cannot in terms of functionality, ease of installation, and corrosion resistance.

In designing a thermoplastic water system, the following items need to be considered:

- Materials of Construction
- Operating Parameters
- Codes
- Layout Recommendations
- Thermal Expansion
- UV Exposure
- Hanging
- Welding Methods

**Materials of Construction**

For the construction of ventilation systems, Asahi/America provides the ProVent system. ProVent components are now available in Polypropylene and PVDF. The system is designed specifically for ventilation and transport of hazardous fumes and potentially corrosive gases. Both polypropylene and PVDF offer different resistance to chemical applications that should be verified prior to purchase.

**Operating Parameters**

The ProVent system is available in multiple wall thickness in polypropylene. The selection of material pressure rating shall be based on the following criteria:

- Operating temperature
- Media to be transported
- Operating pressure, positive or negative
- Economics
- Required fire codes
- Size to be installed

By evaluating the above parameters, the proper system can be chosen. In many applications polypropylene will more than exceed the application; however, if the media to be transported is at an elevated temperature PVDF may be required.

In general, PP systems are available in a larger selection of sizes and pressure rating options. Refer to Asahi/America's *ProVent Dimensional Guide* for availability of components.

**Codes**

In designing a ventilation system, the most pertinent code may be the fire code or the need for Factory Mutual approval. ProVent systems made of polypropylene can be installed according to FM regulations and the final installed product can meet FM requirements. The use of PP in systems requiring

FM approval will require the use of an internal sprinkler head system. In case of a fire, the sprinkler system would eliminate the possibility of the vent system spreading the fire.

There are sprinkler systems on the market that are specifically designed for this application and dramatically reduce the installation labor, as well as the required sprinkler head inspection process after installation. Figure D-39 shows a detail of a typical flexible sprinkler head and the mounting component offered by Asahi/America.

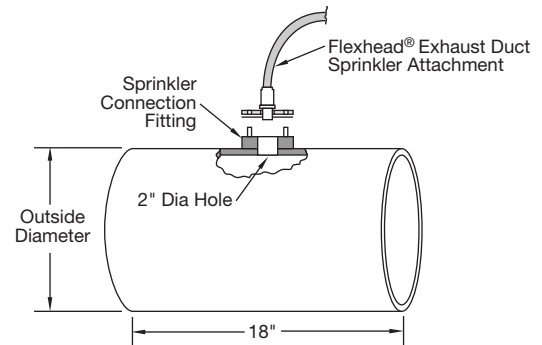

**Figure D-39. Detail of a flexible sprinkler head and mounting component**

ProVent PVDF is a material that is considered self-extinguishing. PVDF has significantly better smoke and flame ratings as compared to most other thermoplastic materials. PVDF material offered by Asahi/America is an FM approved material according to FM 4910 Standards.

Contact Asahi/America for further information on installation requirements for PVDF systems. In addition, Asahi/America has on file the test results according to multiple smoke and flame standards for both polypropylene and PVDF.

In short, there may be a need or requirement for internal closed-head sprinklers in a ProVent system if combustible materials can accumulate inside the pipe line.

**Layout Recommendations**

Ventilation systems are often the most custom design of any pipe system in the factory. They are large in diameter and generally need to be connected to multiple equipment vents. Asahi/America offers a wide range of standard components for assembling a system.

However, many systems cannot be accomplished using standard components. A skilled installer can make special fabrications in the field to accomplish the layout requirement of a system. In addition, Asahi/America can design and prefabricate pipe systems and ship them ready for installation. Figure D-40 shows a detail of a component that could not be made with standard fittings, but can easily be produced in Asahi/America's fabrication shop and shipped to the job-site ready to be installed.

Flexhead is a registered trademark of Flexhead Industries.

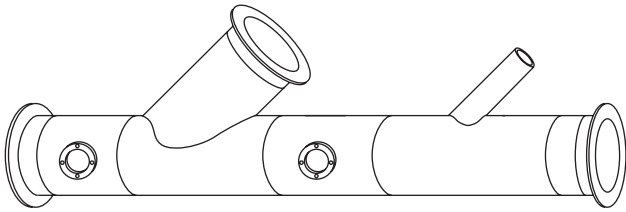

**Figure D-40. Asahi/America prefabricated assembly**

For more information on fabrication assistance, contact Asahi/America's Engineering Department.

## D Thermal Expansion

Based on a system's operating criteria, thermal expansion must be considered. For systems maintained at consistent temperatures, compensation for thermal effects may not be required. It is, however, important to review all aspects of the operating environment such as:

- Is it outdoors where it will be exposed to changing weather?
- Is the system spiked with a high temperature cleaning solution?
- Will the system run at a significantly higher temperature than the installation temperature?

The occurrence of any thermal change in a plastic system will cause the material to expand or contract. As an example of the effect, Polypropylene will grow roughly one inch for every 100 linear feet at 10° F  $\Delta T$ .

Ventilation systems will often reach an equilibrium with the temperature of the ambient environment. Therefore, if the pipe is to be hung in a ceiling where the temperature will vary in summer and winter, the change in temperature that most affects the pipe may be due to the ambient temperature changing rather than media temperature changing. This is almost always the case in systems installed outdoors.

ProVent systems can be used in hot applications and applications where the temperature is cyclical; it just requires analysis of the thermal expansion effects. Section C in this guide walks through the steps of calculating thermal expansion, end loads, and expansion compensating devices. In most cases, the use of expansions, offsets, and proper hanging techniques are all that is required to ensure a proper design.

Hot systems also reduce the rigidity of thermoplastic piping, which, in turn, decreases the support spacing between pipe hangers. In smaller dimensions it is recommended to use continuous support made of some type channel or split plastic pipe. Review hanging requirements that are based on the actual operating temperatures.

Finally, the use of hangers as guides and anchors becomes important. As the design procedures in Section C indicate, certain hangers should be used as guides to allow the pipe to move back and forth in-line, while other hangers shall be anchoring locations used to direct the expansion into the compensating device. The anchors and hangers should be designed to withstand the end load generated by the thermal expansion.

For calculation of allowed stresses and design of expansion compensation devices, refer to Section C, *Engineering Theory and Design Considerations*.

## UV Exposure

As a rule, PVDF material is UV resistant and can be installed in direct exposure to sunlight without protection. In certain applications with Chlorine content this may not be true. Free radical Chlorine can cause a breakdown of PVDF when exposed to UV light. For these applications it is best to protect the pipe by wrapping or insulating it. Contact Asahi/America for information on chemicals that can cause this effect.

Polypropylene is not 100% UV stable. Over time, the outer surface of a standard gray Polypropylene pipe will change color and will become brittle. The surface becomes chalky to the touch. Generally if the surface is left untouched, the effect of the UV change will stop and not continue through the pipe. A pipe with a heavy wall thickness may not require protection as the change will only occur on the outer most surface. The effect to the mechanical strength of the pipe will be minimal. However, most ventilation systems operate at low pressures and use thin walled pipe for cost savings. Therefore, the ProVent PP, in most cases, should be wrapped or protected from UV exposure.

## Hanging

Since plastic reacts differently than metal, varying hanger styles are required. The designer of a system should specify the exact hanger and location and not leave this portion up to the installer.

See Appendix A (Pro 45) for the hanging distance required on ProVent systems.

## Welding Methods

There are several options for installing a ProVent system. Most projects will incorporate two or three different joining techniques. The methods are

- Conventional butt fusion
- Hot air welding
- Extrusion welding

ProVent is made to the same outer wall dimensions (DIN Standards) as all other polypropylene and PVDF pipe systems offered by Asahi/America. The same butt-fusion equipment and methodology can be used to assemble these systems. Butt fusion provides full pressure rated welds and offers a high degree of reliability for ventilation welding. However, depending on the size of pipe and location of the welds, butt fusion can be cumbersome. To conduct a weld in a ceiling of 24" pipe will be difficult and will consume a significant amount of time to lift the pipe, the tool, and an operator into position.

In many cases, it is recommended to prefabricate a system on the ground or in a workshop and then conduct final assembly using flange connections. In addition to using flange connections for final hook-up, couplings and slip flanges can be used. These components can be hot air welded or extrusion welded depending on the size of the pipe and the required system operating pressure.

Hand welding, (hot air or extrusion welding) is a convenient method for welding in place or in prefabrication. Below is a detail of a slip coupling being hand welded. This method, while convenient, is highly reliant on an operator's skill. Hot air welding is simple and requires minimal practice to become proficient; however, extrusion welding is more complicated and a more extensive training course is required. Once these skills are mastered, they will prove highly useful during installation. It is recommended on all ProVent projects to buy at least one hot air welding tool as there is always a need for it.

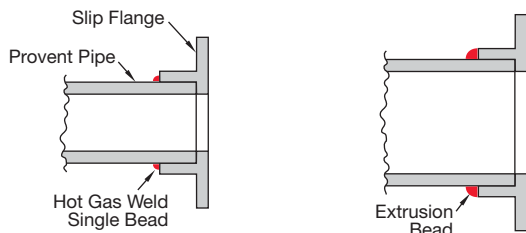

**Figure D-41. Weld option**

**D**

This page intentionally left blank.

### COMPRESSED AIR SYSTEM DESIGN

A compressed air system made of thermoplastic piping is a simplified installation. The Air-Pro system by Asahi/America provides fast, safe installation with all the long-term corrosion resistance of plastics that are ideal for the air systems.

This section reviews the necessary items to consider when designing a compressed air system. The topics covered are:

- Materials of Construction
- Operating Parameters, Oils
- System Sizing
- Thermal Expansion
- Other Considerations
- Hanging
- Welding Methods

#### Materials of Construction

When designing a compressed air system, it is critical to use materials that are manufacturer recommended for the application. Only certain thermoplastics are approved for use in compressed air applications due to safety precautions that must be considered.

Thermoplastics, such as PVC, are not recommended for use in compressed air applications due to its highly crystalline structure. Under pressure, air will compress, generating a high potential energy. In the event of a failure, the release of the compressed air turns the potential energy into kinetic energy, which releases at high velocities as the air decompresses. Brittle materials can shatter and break into fragments at the point failure. The plastic pieces that break off are dangerous to surrounding personnel, causing injury and possible death.

The use of Air-Pro for compressed air service is recommended by Asahi/America, Inc. The Air-Pro system was specifically designed for compressed air. The material's ductile nature makes it safe in the event of any possible failure. In a failure mode, the material will stretch and tear, without the fragmentation of any material. Air-Pro is similar to copper pipe when it breaks open due to failure in a frozen application. Air-Pro has been tested for impact failure at full pressure and full pressure at cold temperatures, displaying safe ductile properties under all conditions.

For compressed air systems, Air-Pro is recommended.

#### Operating Parameters, Oils

Because thermoplastic systems have varying ratings at different temperatures, it is important to design a system around all the parameters that will be subjected to it. As a first pass, verify the following operating parameters:

- Continuous operating temperature
- Continuous operating pressure
- Oil to be used in compressor

By knowing the above parameters, thermal plastic pipe systems can be selected. Compare the actual conditions to the allowable ratings of the material being selected for the job. It is important to predict elevated temperatures, as thermoplastics have reduced pressure ratings at higher temperatures. The Air-Pro system is rated at 230 psi at 68° F. Table D-3 lists correction factors for higher temperatures.

**Table D-3. Air-Pro Pressure Rating Correction Factor**

Temperature (° F)	Correction Factor
68	1.00
86	0.88
104	0.79
140	0.65

Multiply the standard rating of 230 psi by the correction factor that correlates with a system's expected operating temperature.

Valves should be verified separately in terms of temperature and pressure from a piping system, as certain styles and brands of valves have lower ratings than the pipe system.

Finally, in compressed air systems, oil is used in the compressor as a lubricant. Depending on the filter and drying system, it is common for the oil to get into the pipe system. With certain plastics, such as ABS, synthetic oils can break down the plastic or the glue and cause failures over time. For most mineral and synthetic compressor oils, Air-Pro is resistant to the effects of the oil. For an exact recommendation, contact Asahi/America's Engineering Department to verify your oil and application.

After verifying the standard operating conditions, it is necessary to examine other operations that might affect the piping. The following is a sample of items to investigate, prior to specifying a material.

- Will there be spikes in temperature or pressure?
- Is there a cleaning operation that the piping will be exposed to?
- If yes, what is the cleaning agent? What temperature will the cleaning be conducted at?
- Will the system be exposed to sunlight or other sources of UV?

Each of the above questions should be answered and the desired material should be checked for suitability based on the above factors, as well as any others that might be special to the system in question.

#### System Sizing

Designing pipe lines for compressed air or gas is considerably different from designing a non-compressible liquid system. Gases are compressible, so there are more variables to consider. Designs should take into account current and future demands to avoid unnecessarily large pressure drops as a system is expanded. Elevated pressure drops represent unrecoverable energy and financial losses.



One advantage in designing an Air-Pro system is its smooth internal bore and resistance to corrosion in moist environments, which means the material can be used for years with extraordinarily low maintenance and without increases in pressure drop common to metal systems. Condensate and moist environments cause most metal systems to scale, pit, and corrode, resulting in increased pressure drop. For Air-Pro piping, the roughness factor, *C*, of the pipe internals is approximately 150 to 165. This factor is inversely proportional to friction head losses. As *C* decreases, system friction increases. Since Air-Pro pipe is resistant to corrosion, the roughness factor will not decrease over time, thus the pressure drop will not increase. Conversely, a carbon steel system with an initial roughness factor of 120 will scale over time, causing an increase in friction, increased pressure drops, and greater demand on the air compressor unit.

## Main Lines

Normal compressed air systems incorporate two types of pipe lines when designed correctly: the main (or the trunk) line and the branch lines. Main lines are used to carry the bulk of the compressed gas. Undersizing the main line can create large pressure drops and high velocities throughout the system. In general, systems should be oversized to allow for future expansion, as well as reduce demand on the compressor.

Oversizing the main line will be more of an initial capital expense, but can prove to be an advantage over time. In addition to reducing pressure drop, the extra volume in the trunk line acts as an added receiver, reducing compressor demand and allowing for future expansion. Small mains with high velocities can also cause problems with condensed water. High air velocities pick up the condensed water and spray it through the line. With a larger diameter, velocities are lowered, allowing water to collect on the bottom of the pipe while air flows over the top. A generally accepted value for velocity in the main line is 20 feet per second. It may also be preferable to arrange the mains in a loop to have the entire pipe act as a reservoir.

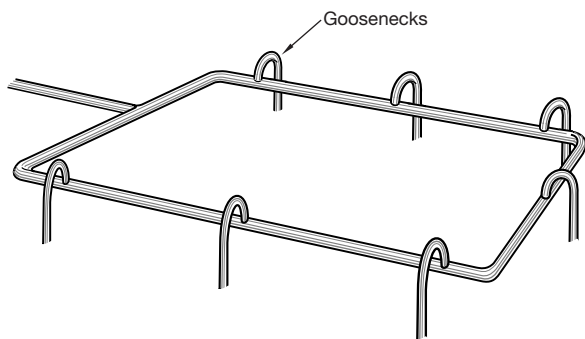

Figure D-42. Main compressed air loop with branches

To design the main line of a compressed gas system, Equation D-1 has been developed:

$$d = (0.00067 L Q^{1.85} \Delta P)^{0.2} \quad (D-1)$$

where: *d* = inside diameter (in)  
*L* = length of main line (ft)  
*Q* = standard volumetric flow rate (make-up air)  
*P* = output pressure from the compressor (psi)  
 $\Delta P$  = allowable pressure drop (psi)

Equation D-1 relates the pipe's inside diameter (*d*) to the pressure drop. In order to use the equation, certain information must be known. First, the required air consumption must be predetermined. Based on required air consumption, a compressor can be chosen with an output pressure rating (*P*). The length of the main pipe line to be installed, and the number of fittings in the main line must also be known. For fittings, use Appendix A to determine the equivalent length of pipe per fitting style. The allowable pressure in the system has to be specified. Typically, a value of 4 psi or less is used as a general rule of thumb for compressed air systems.

To summarize, the following data should be specified:

*L* = length of main line (ft)  
*Q* = standard volumetric flow rate (make-up air)  
*P* = output pressure from the compressor (psi)  
 $\Delta P$  = allowable pressure drop (psi)

## Branch Lines

Lines of 100 feet or less coming off the main line are referred to as branch lines. Since these lines are relatively short in length, and the water from condensation is separated in the main lines, branches are generally sized smaller and allow for higher velocities and pressure drops.

To prevent water from entering the branch line, gooseneck fittings are used to draw air from the top of the main line, leaving condensed water on the bottom of the main line.

## Thermal Expansion

Based on your operating criteria, thermal expansion must be considered. For systems maintained at consistent temperatures, compensation for thermal effects may not be required. It is, however, important to review all aspects of the operating environment, such as:

- Is it outdoors where the pipe will be exposed to changing weather?
- Is the system spiked with a high temperature cleaning solution?
- Will the system run at a significantly higher temperature than the installation temperature?

The occurrence of any thermal change in a plastic system will cause the material to expand or contract.

Thermoplastic systems can be used in hot applications and applications where the temperature is cyclical. It just requires analysis of the thermal expansion effects. Section C discusses the steps of calculating thermal expansion, end loads, and expansion compensating devices. In most cases the use of expansions, offsets, and proper hanging techniques is all that is required to ensure a proper design.

Hot systems also reduce the rigidity of thermoplastic piping pipe, which, in turn, decreases the support spacing between pipe hangers. In smaller dimensions, using continuous supports made of some type of channel or split plastic pipe is recommended.

Finally, the use of hangers as guides and anchors becomes important. As the design procedures in Section C indicate, certain hangers should be used as guides to allow the pipe to move back and forth in-line, while other hangers should be anchoring locations used to direct the expansion into the compensating device. The anchors and hangers should be designed to withstand the thermal end load.

For calculation of allowed stresses and design of expansion compensation devices, refer to Section C, *Engineering Theory and Design Considerations*.

**Other Considerations**

**UV Exposure**

The Air-Pro system is not rated for direct UV exposure. In certain outdoor applications, wrapping the pipe for protection is recommended. There are a variety of methods to accomplish this wrapping. Consult with Asahi/America’s Engineering Department for recommendations on Air-Pro in UV exposed applications.

**Insulation**

Insulation is a nice method of protecting a pipe system from UV exposure, as well as providing required insulation for the system or media being transported. A serious difference between plastic and metal is plastic’s thermal properties. A metal pipe system will quickly take the temperature of the media being transported. A system carrying a media at 150° F will have an outer wall temperature close to or at 150° F. In contrast, thermoplastics have an inherent insulating property that maintains heat inside the pipe better than a metal system. The advantage is that a plastic pipe has better thermal properties, which translates into improved operating efficiencies and reduced insulation thickness.

**Direct Connection to a Compressor**

As with any material, Air-Pro has upper temperature and pressure rating limitations. For the majority of compressed air systems, Air-Pro is ideal and meets the requirements. One common concern with compressed air systems is the temperature of the air directly leaving the compressor. In many cases, this temperature is extremely high and can exceed the rating of Air-Pro. In these locations, it is not recommended to directly attach the Air-Pro system to the compressor. Instead, start the Air-Pro system after a cooler or dryer, where temperatures are lower. In between the compressor and the dryer/cooler, use metal piping to handle the higher temperatures. The length of metal pipe in these locations is generally very little and should have minimal effect on the air quality.

**Hanging**

Since plastic reacts differently than metal, varying hanger styles are required. The designer of a system should specify the exact hanger and location and not leave this portion up to the installer. Use Table D-4 for determining the hanging distance required on Air-Pro systems.

In smaller dimensions, it may be advantageous to use a continuous support for horizontal piping.

**Table D-4. Maximum Hanging Distances for Air-Pro Systems**

Pipe Size (inches)	Support Spacing (° F)	
	68° F	104° F
1/2	2.8	2.6
3/4	3.2	2.9
1	3.6	3.3
1 1/4	4.1	3.6
1 1/2	4.5	4.1
2	5.1	4.6
3	8.4	8.1

**Welding Methods**

The system designer should specify the equipment method to be used in any given project. The choice of particular equipment should be based on the following concerns:

- Installation location
- Size range
- System complexity

Socket fusion is ideal for small, simple, low cost systems. Socket fusion can be done quite easily with a hand-held welding plate and a few inserts. With just a limited amount of practice, an installer can make safe and reliable joints. For larger dimensions, up to a maximum of 4", bench style socket fusion equipment is available for keeping joints aligned.



For systems that have larger dimensions above 4", butt fusion is a logical choice. Welding can take place in a variety of climates and conditions. In addition, butt fusion offers the widest variety of welding equipment options. Tools are available for bench welding, trench welding, and welding in the rack, making it completely versatile for almost all applications. Refer to Section F, *Installation Practices*, for a tool selection guide.

Since Air-Pro is available as a socket system from 1/2" to 4", the only selection of equipment is between the hand-held tool or the larger bench style tool. However, if a system is mostly pipe with long straight runs, then the use of butt fusion can be considered. Using butt fusion on the pipe-to-pipe welds will reduce the amount of welds, as well as decrease the need for coupling fittings to connect the pipe. However, in these installations, two welding methods on the job site are required: butt fusion for the pipe and socket fusion for the fitting connections.

For a more detailed analysis of welding methods and equipment, refer to Section F, *Installation Practices*.