

# PRO-LOCK™ PVC & CPVC Double Containment Piping System



The newest addition to Asahi/America's Double Containment product line, the Pro-Lock PVC & CPVC Double Wall Piping system, combines engineering design with cost effective materials. Available in high density PVC in a variety of sizes & wall thickness options, Pro-Lock is a reliable double wall system for a variety of applications. Pro-Lock exceeds the requirements of EPA Standard 40 CFR, Part 280 for underground transport of hazardous chemicals.



## Size Range:

1/2x2, 3/4x3, 1x3, 1x4, 2x4, 2x6, 3x6, 4x8 and 6x10  
Sch 40 x 40 PVC, Sch80 x 40 PVC,  
Sch 80 x 80 PVC & CPVC  
CPVC x PVC are available

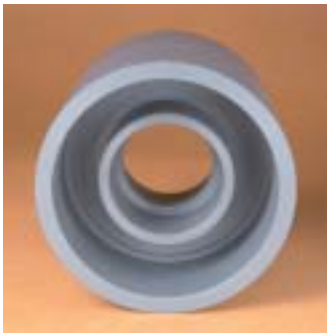

Patented Dogbone Fitting

## Fittings:

90 & 45 degree elbows, tees, access tees, reducers, flanged end terminations, slip couplings, dogbones, restraint dogbones and lowpoint stations,

## Recommended Applications:

Water Treatment, Wastewater Treatment, Chemical Processing, Pharmaceutical, Semiconductor

## Engineered Containment

At the heart of all Asahi/America's double containment piping systems is the patented Dogbone fitting.

- Termination from double wall pipe to single wall systems
- Locks the inner carrier pipe to the containment for proper stress control
- Compartmentalizes annular space for isolation control of system leaks
- Control and restraint of system expansion forces

## Design & Installation

Pro-Lock system's design consists of a centralizing support disk inside the containment pipe & fitting, minimizing carrier pipe deflection & extending the life of the systems. Fittings are made of the same resin as the pipe and are available in a variety of configurations for pressure applications. Fittings are supplied from the factory dual contained and locked together ready for installation.







Pro-Lock is assembled in the field using staggered or simultaneous joining methods. Joining cements are recommended based on your application. Pro-Lock fittings and pipe are NSF-61 certified and IAPMO approved. For more information on codes, contact Asahi/America's technical staff.

## Service & Support

Asahi/America's engineering staff is poised to assist and review each and every system design. Consultation is readily available for fluid dynamics, stress analysis, pipe burial, pipe hanging & chemical resistance checks for the media transported.

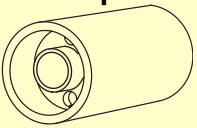
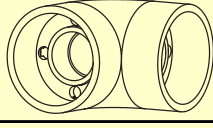
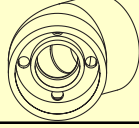
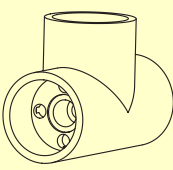
# PRO-LOCK™ FITTINGS

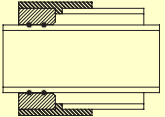
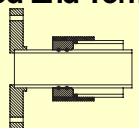
Creating your double containment system is easy using this large selection of fittings.

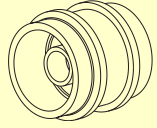
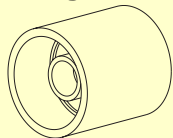
 <p>Pipe</p>	<p>PVC 80x80 1/2x2-4x8                  PVC 80x40 3/4x3-4x8                  PVC 40x40 1x3-4x8                  CPVC 80x80 1/2x2-4x8</p>
 <p>90 Elbow</p>	<p>PVC 80x80 1/2x2-4x8                  PVC 80x40 3/4x3-4x8                  PVC 40x40 1x3-4x8                  CPVC 80x80 1/2x2-4x8</p>
 <p>45 Elbow</p>	<p>PVC 80x80 1/2x2-4x8                  PVC 80x40 3/4x3-4x8                  PVC 40x40 1x3-4x8                  CPVC 80x80 1/2x2-4x8</p>
 <p>Tees</p>	<p>PVC 80x80 1/2x2-4x8                  PVC 80x40 3/4x3-4x8                  PVC 40x40 1x3-4x8                  CPVC 80x80 1/2x2-4x8</p>
 <p>Reducers</p>	<p>PVC 80x80 1/2x2-4x8                  PVC 80x40 3/4x3-4x8                  PVC 40x40 1x3-4x8                  CPVC 80x80 1/2x2-4x8</p>
 <p>2 Piece End Termination</p>	<p>PVC 80x80 1/2x2-4x8                  PVC 80x40 3/4x3-4x8                  PVC 40x40 1x3-4x8                  CPVC 80x80 1/2x2-4x8</p>
 <p>Flanged End Termination</p>	<p>PVC 80x80 1/2x2-4x8                  PVC 80x40 3/4x3-4x8                  PVC 40x40 1x3-4x8                  CPVC 80x80 1/2x2-4x8</p>
 <p>Slip Coupling</p>	<p>Sch 40 3"-8" PVC                  Sch 80 2"-8" PVC                  Sch 80x80 2"-8" CPVC</p>
 <p>Restraint Dogbone</p>	<p>PVC 80x80 1/2x2-4x8                  PVC 80x40 3/4x3-4x8                  PVC 40x40 1x3-4x8                  CPVC 80x80 1/2x2-4x8</p>
 <p>Dogbone</p>	<p>PVC 80x80 1/2x2-4x8                  PVC 80x40 3/4x3-4x8                  PVC 40x40 1x3-4x8                  CPVC 80x80 1/2x2-4x8</p>

# PRO-LOCK™ OPTIONS

Enhance your double containment system by adding these special fitting options.

### Access Ports

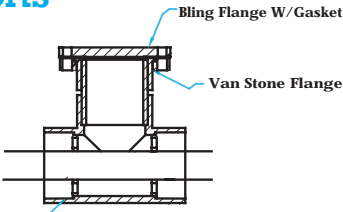

Typ: Flanged Access Port

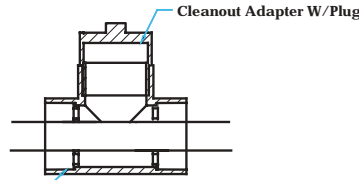

Typ: Thread Access Port

Note: Hardware not included

### Low Point Station

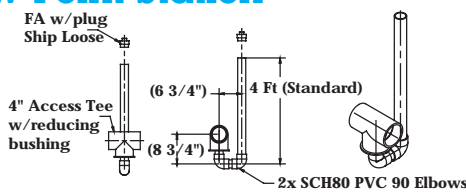

4" Access Tee w/reducing bushing

FA w/plug Ship Loose

(6 3/4")

4 Ft (Standard)

(8 3/4")

2x SCH80 PVC 90 Elbows

### Valve Box

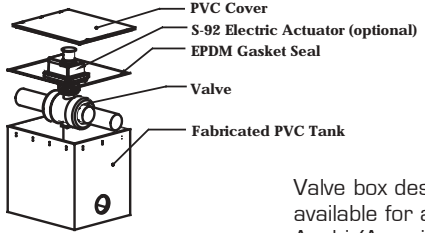

PVC Cover

S-92 Electric Actuator (optional)

EPDM Gasket Seal

Valve

Fabricated PVC Tank

Valve box designs are available for all Asahi/America valves.

### Leak Detection

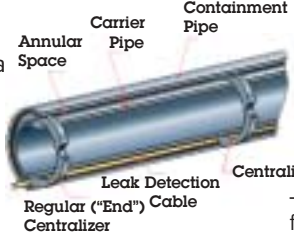

Annular Space

Carrier Pipe

Containment Pipe

Leak Detection Regular ("End") Cable

Centralizer

Asahi/America offers two state-of-the-art leak detection systems

-PAL-AT: A continuous leak detection cable system that can incorporate probes & float switches

-Liquid Watch: A flexible, modular low point system based on inline probes.

PAL-AT and Liquid Watch are Registered trademarks of Perma Alert.

### Fabrication

Save Time and Money: Have Asahi/America layout your system and build it in our facility.

