

Serial No.	H-V066-E-0
------------	------------

# Wafer Check Valve

## User's Manual





### Contents



- (1) Be sure to read the following description  
of our product warranty ..... 1
- (2) General operating instructions ..... 2
- (3) General instructions for transportation,  
unpacking and storage ..... 3
- (4) Name of parts ..... 4
- (5) Comparison between working  
temperature and pressure ..... 5
- (6) Minimum Seal performance ..... 5
- (7) Installation procedure ..... 6
- (8) Disassembling method for replacing parts ..... 8
- (9) Inspection items ..... 9
- (10) Troubleshooting ..... 9
- (11) Handling of residual and  
waste materials ..... 9

This User's Guide contains information important to the proper installation, maintenance and safe use of the ASAHI AV product store in an easily accessible location.

<Warning & Caution Signs>

 Warning	This remark expresses the user to take caution due to the potential for serious injury or death.
 Caution	This remark expresses the user to take caution due to the potential for damage to the valve if used in such a manner.



<Prohibition & Mandatory Action Signs>



	Prohibition: When operating the valve, this remark indicates an action that should not be taken.
	Mandatory action: When operating the valve, this remark indicates mandatory actions that must be adhered to.

(1) Be sure to read the following description of our product warranty.

- Always observe the specifications of and the precautions and instructions on using our product.
- We always strive to improve product quality and reliability, but cannot guarantee perfection. Therefore, should you intend to use this product with any equipment or machinery that may pose the risk of serious or even fatal injury, or property damage, ensure an appropriate safety design or take other measures with sufficient consideration given to possible problems. We shall assume no responsibility for any inconvenience stemming from any action on your part without our written consent in the form of specifications or other documented approval.
- The related technical documents, operation manuals, and other documentation prescribe precautions on selecting, constructing, installing, operating, maintaining, and servicing our products. For details, consult with our nearest distributor or agent.
- Our product warranty extends for one and a half years after the product is shipped from our factory or one year after the product is installed, whichever comes first. Any product abnormality that occurs during the warranty period or which is reported to us will be investigated immediately to identify its cause. Should our product be deemed defective, we shall assume the responsibility to repair or replace it free of charge.
- Any repair or replacement needed after the warranty period ends shall be charged to the customer.
- The warranty does not cover the following cases:
  - (1) Using our product under any condition not covered by our defined scope of warranty.
  - (2) Failure to observe our defined precautions or instructions regarding the construction, installation, handling, maintenance, or servicing of our product.
  - (3) Any inconvenience caused by any product other than ours.
  - (4) Remodeling or otherwise modifying our product by anyone other than us.
  - (5) Using any part of our product for anything other than the intended use of the product.
  - (6) Any abnormality that occurs due to a natural disaster, accident, or other incident not stemming from something inside our product.

**(2) General operating instruction**

- 

**Warning** - Using a positive-pressure gas with our plastic piping may pose a dangerous condition due to the repellent force particular to compressed fluids, even when the gas is under the same pressure as water. Therefore, be sure to take the necessary safety precautions such as covering the piping with protective material. For inquiries, please contact us. For conducting a leak test on newly installed piping, be sure to check for leaks under water pressure. If absolutely necessary to use gas in testing, please consult your nearest service station beforehand.
- 

**Caution** - Do not step on the valve or apply excessive weight on valve. (It can be damaged.)
- 

- Keep the valve away from excessive heat or fire. (It can be damaged, or destroyed.)

- Operate the valve within the pressure Vs temperature range.  
(The valve can be damaged by operating beyond the allowable range.)

- Allow sufficient space for maintenance and inspection.

- Select a valve material that is compatible with the media, refer to “CHEMICAL RESISTANCE ON ASAHI AV VALVE”. (Some chemicals may damage incompatible valve materials.)



- Do not use the valve on condition that fluid has crystallized. (The valve will not operate properly.)

- Keep the valve away from places of direct sunlight, water and dust. Use cover to shield the valve.  
(The valve will not operate properly.)



- Perform periodic maintenance. (Leakage may develop due to temperature changes or changes with time during prolonged storage, rest, or operation.)

- Use the valve at a pressure exceeding the minimum operating differential pressure.  
(Check the effective head.)

(3) General instructions for transportation, unpacking and storage

  - In suspending and supporting a valve, take enough care and do not stand under a suspended valve.

Warning

  - The valve is not designed to handle any kind of impact. Avoid throwing or dropping the valve.

Caution

- Avoid scratching the valve with any sharp object.
- Do not pile up corrugated cardboard packages one on top of another too much. Excessively piled-up packages may collapse.
- Avoid contact with any coal tar creosote, insecticides, vermicides or paint. (The force of swelling may damage the valve.)

 - Be sure to carry a valve as shown in the following pictures, or parts of valve may be damaged by excessive stresses.



Correct position



Do not allow Disc to hang



Do not carry by Disc

- Keep the piping in the corrugated cardboard boxes, avoid direct sunlight, and store it indoors (at Room Temperature). Also avoid storing it in a place which may become very hot. (Corrugated cardboard packages become weaker as they become wet with water or other liquid. Take enough care in storage and handling.)
- After unpacking the products, check that they are defect-free and meet the specifications.

(4) Name of parts

Nominal size 250, 300mm (10", 12")

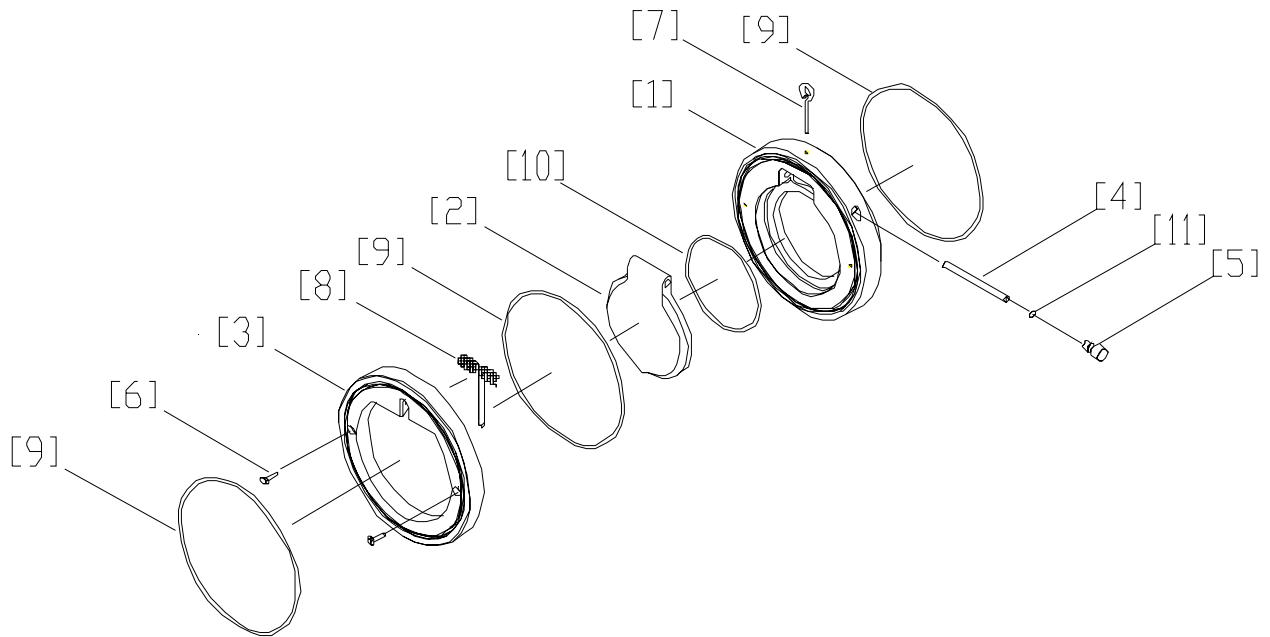

No.	DESCRIPTION	No.	DESCRIPTION
[1]	Body	[7]	I Bolt
[2]	Disc	[8]	Spring *
[3]	Stopper	[9]	O-ring (A)
[4]	Shaft	[10]	O-ring (B)
[5]	Plug	[11]	O-ring (C)
[6]	ASAHI AV Bolt		

\*Only for spring type

(5) Comparison between working temperature and pressure

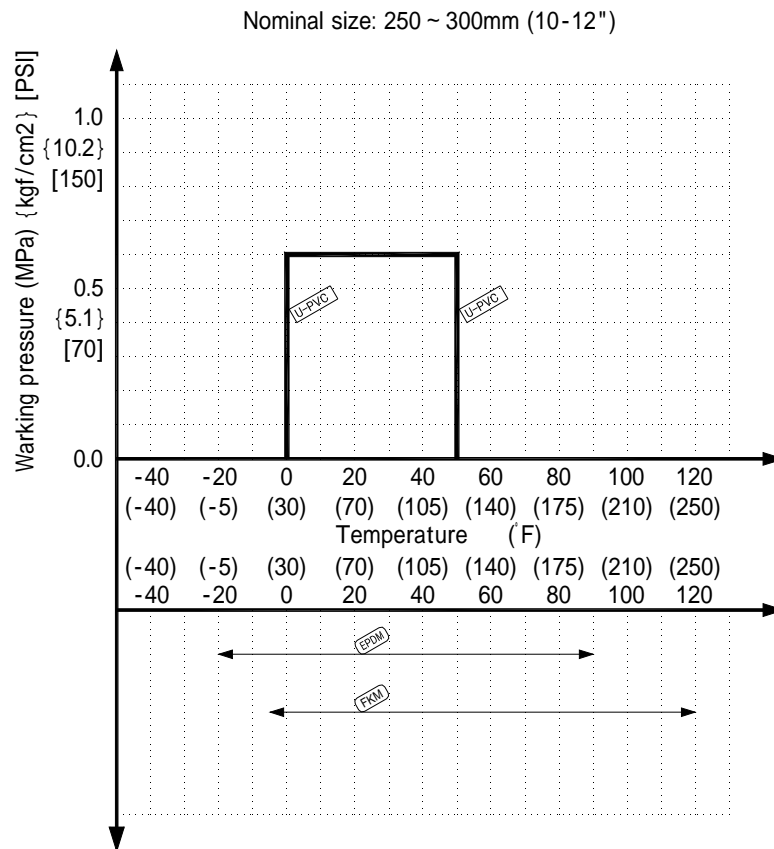

(6) Minimum seal performance (Water Pressure: at R. T.)

Unit: kPa {gf/cm<sup>2</sup>} [PSI]

Nominal Size		Vertical Piping		Horizontal Piping	
mm	inch	Shut the Disc	Open the Disc	Shut the Disc	Open the Disc
250	10"	7.0 {70.0} [1.0]	0.7 {7.0} [0.1]	7.0 {70.0} [1.0]	0.07 {0.7} [0.01]
300	12"	7.0 {70.0} [1.0]	0.7 {7.0} [0.1]	7.0 {70.0} [1.0]	0.07 {0.7} [0.01]

\*Data mentioned in the table above is reference only.

(7) Installation procedure



Warning



- In suspending and supporting a valve, take enough care and do not stand under a suspended valve.

- Be sure to conduct a safety check on the machine tools and motor-driven tools to be used, before beginning work.

- Wear protective gloves and safety goggles as fluid remains in the valve. (You may be injured.)



Caution

- When installing a pipe support by means of a U-band or something similar, take care not to fasten it too much. (Excessive tension may damage it.)

- Do not use the valve for the pulsating fluid.



- Do not mount valve directly on pump outlet

- When installing pipes and valves, ensure that they are not subjected to tension, compression, bending, impact, or other excessive stress.

- The valve is applicable to both types: vertical and horizontal piping. In the case of vertical piping, use the valve in applications where the fluid travels upwards.

- Take care to properly install the valve by aligning flow direction arrow with intended direction of flow

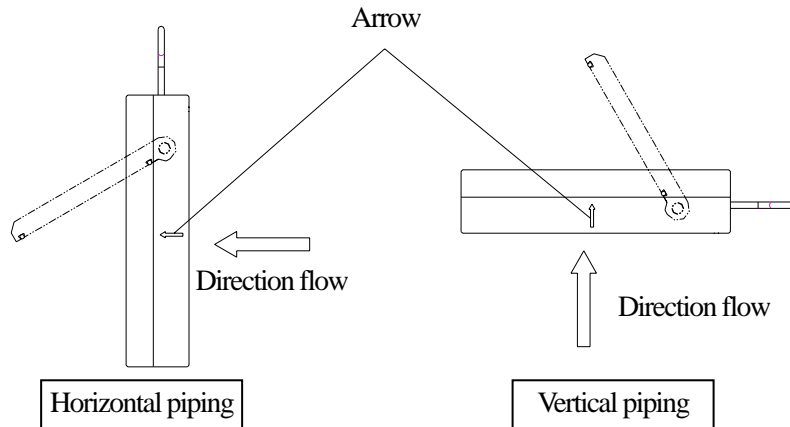

- Care must be used during piping installation to ensure that the pipe inside diameter of the downstream piping is larger than size D so that the valve disc does not contact piping in any setting.

Nominal size	Diameter D
250mm (10")	241mm (9.49")
300mm (12")	287mm (11.3")

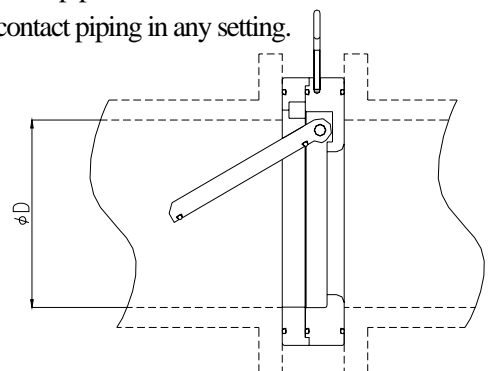

- Use flat faced flanges for connection to AV Valves.
- Ensure that the mating flanges are of the same standards.
- Be sure to use bolts, nuts, and washers and tighten them to specified torques.
- The gasket is unnecessary. (The O-ring (A) carries out the role of the gasket.)

Necessary items

- Torque wrench
- Spanner wrench
- Bolt, Nut, Washer (For many flanges specification)

Procedure

- 1) Install the valve between flanges after extending the fields of flanges fully.
- 2) Insert bolts, set nuts and washer and tighten the bolts and nuts temporarily by hand.  
(When installing a valve, refer to the following picture for the detail.)

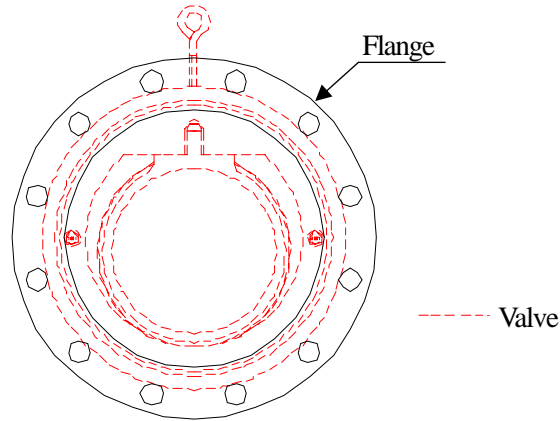

- The parallelism and axial misalignment of the flange surface should be under the values shown in the following table to prevent damage the valve.

(A failure to observe them can cause destruction due to stress application to the pipe)

Unit : mm (inch)

Nom. Size	Axial misalignment	Parallelism (a-b)
250, 300mm (10" - 12")	1.5 (0.06")	1.0 (0.04")

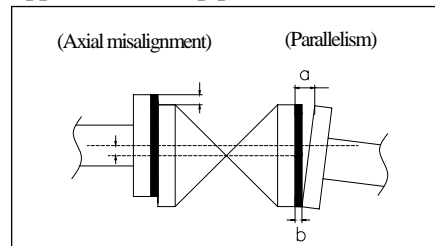

- 3) Using a torque wrench, tighten the bolts and nuts gradually to the specified torque in a diagonal manner.  
(Refer to fig.1.)



- Tighten the bolts and nuts gradually with a torque wrench to the specified torque level in a diagonal manner.

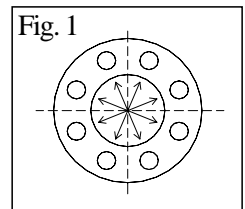



Recommended torque value

Unit: N·m {kgf·cm} [lb·inch]

Nom. Size	250mm (10")	300mm (12")
Torque value	55.0 {561} [488]	60.0 {612} [532]

**(8) Disassembling method for replacing parts**



**Warning**   - Be sure to conduct a safety check on all hand and power tools to be used before beginning work.  
 - Wear protective gloves and safety goggles as fluid remain in the valve even if the pipeline is empty.  
 (You may be injured.)  
 - Do not change or replace valve parts under line pressure.

Necessary items

Socket wrench (M8)	Screw driver (-)	Bolt (M8)
Protective gloves	Safety goggles	

<Disassembly>

- 1) Drain the fluid completely from the pipe line.
- 2) Loosen the connecting bolts and nuts, and remove the valve from pipe line.
- 3) Loosen the AV Bolt [6] by using a socket wrench, and remove the stopper [3] with spring [8]\* from the body [1].  
 \*Only for spring type
- 4) Loosen the plug [5] by using screw driver (-) and remove it.
- 5) Thrust the bolt (M8) to the threaded hole of shaft [4] and pull out the shaft [4] from the body [1].
- 6) Remove the Disc [2] from the body [1].



**Caution**   - Avoid damaging the O-ring and any other part of the valve when installing or removing the O-ring.

<Assembly>

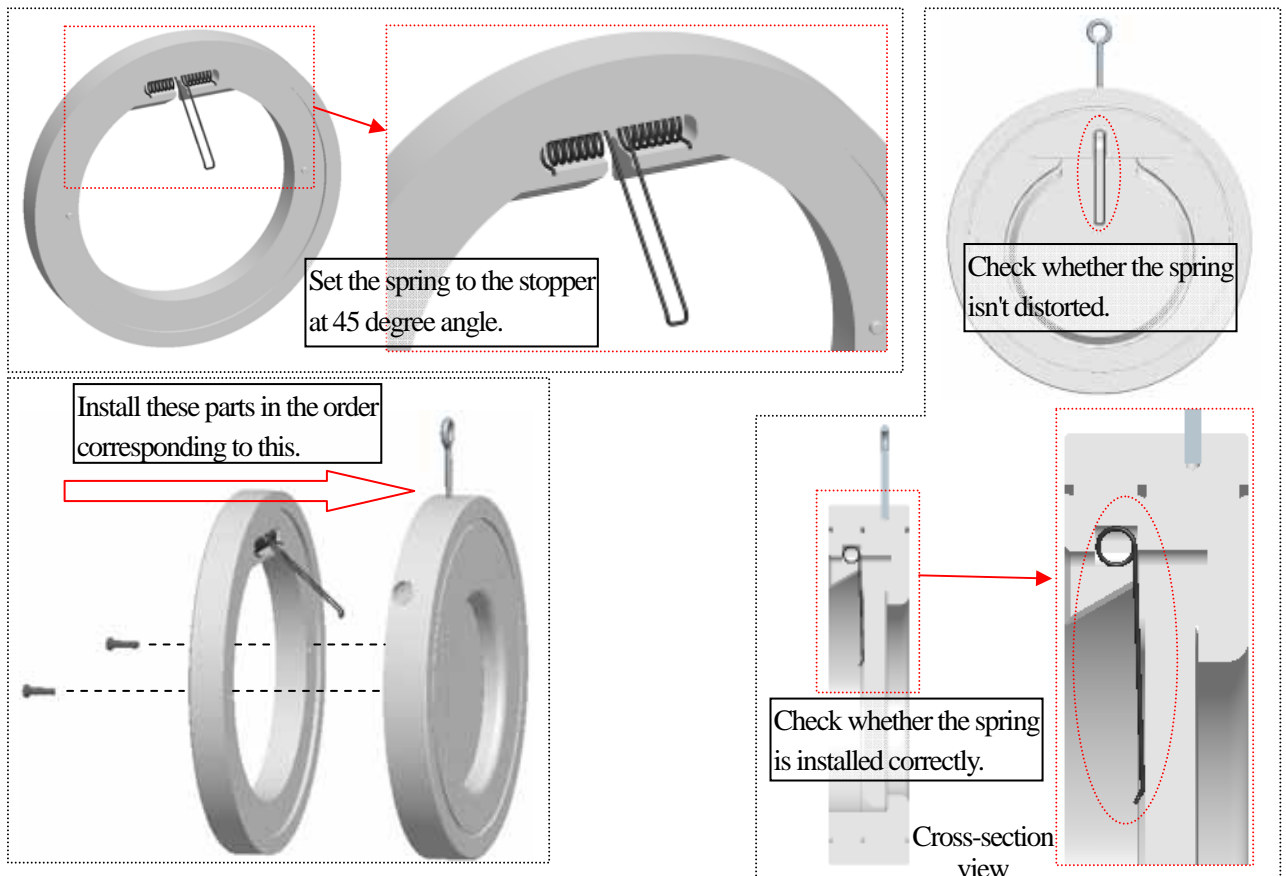
- 1) The procedure of assembly is the almost reverse of its disassembly.  
 Refer to the following picture for the direction of spring



**(9) Inspection items**

  - Perform periodic maintenance. (Leakage may develop due to temperature changes or changes with time during prolonged storage, rest, or operation.)



Inspect the follow items ;

(1)	Check for any flaw, crack, or deformation on the outside.
(2)	Check whether fluid leaks to the outside.
(3)	Check whether tightness of bolt nut.

**(10) Troubleshooting**

Problem	Cause	Treatment
The valve does not work.	The disc contacts to the pipe inside diameter.	Check the pipe inside diameter. (Refer to page 6)
	The direction of the valve is wrong.	Install the valve in the correct direction. (Refer to page 6)
The Fluid is leaking past the fully closed position.	The minimum sealing pressure is low.	Check for the minimum sealing pressure. (Refer to page5)
	O-ring is worn or damaged	Replace the O-ring. (Refer to page 8)
	Solid particles have lodged in the valve.	Remove the solid particles from the valve and clean up the valve.
Outside leakage was occurred.	O-ring is worn or damaged	Replace the O-ring. (Refer to page 8)
	Tightness of bolts and nuts.	Retighten the bolts and nuts.

**(11) Handling of residual and waste materials**

  - Make sure to consult a waste treatment dealer to dispose of the valves. (Poisonous gas is generated when the valve is burned improperly.)

## Wafer Check Valve



ASAHI AV VALVES

---

**Distributor**

Asahi Organic Chemicals Industry's homepage

<http://www.asahi-yukizai.co.jp/en/>